

COBRA

MODEL: RM514SPC (DYM162611)

COBRA LAWN MOWER OWNER'S MANUAL



Cobra Garden Machinery

Henton and Chattell Ltd., London Road, Nottingham NG2 3HW UK

www.cobragarden.co.uk

CONTENTS

SECTION 1	SYMBOLS MARKED ON THE PRODUCT.....	3
SECTION 2	GENERAL SAFETY RULES.....	3
SECTION 3	PARTS DESCRIPTION.....	6
SECTION 4	TECHNICAL DATA.....	6
SECTION 5	ASSEMBLY.....	7
SECTION 6	OPERATION INSTRUCTIONS.....	9
SECTION 7	MAINTENANCE INSTRUCTIONS.....	13
SECTION 8	LUBRICATION INSTRUCTIONS.....	14
SECTION 9	CLEANING.....	14
SECTION 10	STORAGE INSTRUCTIONS (OFF SEASON).....	15
SECTION 11	TROUBLESHOOTING	17
SECTION 12	WARRANTY.....	18
SECTION 13	ENVIRONMENT.....	18
SECTION 14	EC-DECLARATION OF CONFORMITY.....	19

! WARNING:

For your own safety please read this manual before attempting to operate your new mower. Failure to follow instructions can result in serious personal injury. Spend a few moments to familiarise yourself with your mower before each use.

1. SYMBOLS MARKED ON THE PRODUCT



Fig. A

B.1 Read Operator's Manual.

B.2 Keep bystanders away.

B.3 Pay attention to the operator's hands and feet to avoid injury.

B.4 Fuel is flammable, keep fire away. Do not add fuel with running machine.

B.5 Toxic fumes; don't operate indoors, including your garage or shed.

B.6 When mowing, please wear protective glasses and ear plugs to defend the operator himself.

B.7 When repairing, please remove the spark plug, before undertaking repair work according to the operational manual.

B.8 Caution: Engine hot.



Figure B: Safety Label Found On Lawn Mower: KEEP HANDS AND FEET AWAY.

2. GENERAL SAFETY RULES

! WARNING: When using petrol tools, basic safety precautions, including the following, should always be followed to reduce the risk of serious personal injury and/or damage to the unit. Read all these instruction before operating this product and retain these instructions for future reference.

! WARNING: This machine produces an electromagnetic field during operation. This field may under some circumstances interfere with active or passive medical implants. To reduce the risk of serious or fatal injury, we recommend persons with medical implants to consult their physician and the medical implant manufacturer before operating this machine.

Training

1. Before using the lawnmower read the instructions carefully. Familiarise yourself with the controls and pay particular attention in learning how to stop the machine in an emergency.
2. Never allow children or people unfamiliar with these instructions to use the lawn mower. Local regulations can restrict the age of the operator.
3. Never mow while people, especially children or pets are nearby.
4. Never use the mower if the operator is taking medicine or substances that could affect or impair his ability to react or concentrate.
5. Keep in mind that the operator or user is responsible for accidents or hazards occurring to other people or their property.

Before you start

1. While mowing, always wear substantial footwear and long trousers. Do not operate the equipment when barefoot or wearing open toed sandals.
2. Thoroughly inspect the area where the equipment is to be used and remove all objects which can damage or be thrown by the machine.
3. **WARNING** - Petrol is highly flammable.
 - Store fuel in containers specifically designed for this purpose.
 - Refuel outdoors only and do not smoke while refuelling; add fuel before starting the engine.
 - Never remove the cap of the fuel tank or add petrol while the engine is running or when the engine is hot.
 - If petrol is spilled, do not attempt to start the engine, but move the machine away from the area of spillage and avoid creating any source of ignition until petrol vapours have dissipated.
 - Replace all fuel tank and container caps securely.
4. Replace faulty silencers.
5. Before using, always visually inspect to see that the blade, blade bolts and cutter assembly are not worn or damaged. Replace worn or damaged blades and bolts in sets to preserve balance.

Operation and Caution

1. Do not operate the engine in a confined space where dangerous carbon monoxide fumes can collect, refuel outdoors only.
2. Mow only in daylight or in good artificial light.
3. Avoid operating the equipment in wet grass, where feasible.
4. Always be sure of your footing on slopes.
5. Walk, never run, always be in control of the lawnmower and never allow yourself to be pulled along.
6. For wheeled rotary machines, mow across the face of slopes, never up and down.
7. Exercise extreme caution when changing direction on slopes.
8. Do not mow excessively steep slopes of more than 20°
9. Use extreme caution when reversing or pulling the lawn mower towards you.
10. Stop the blade if the lawn mower has to be tilted for transportation when crossing surfaces other than grass, and when transporting the lawn mower to and from the area to be mowed
11. Never operate the lawn mower with defective guards, or without safety devices, for example deflectors and/or grass catchers, in place.
12. Do not change the engine governor settings or over speed the engine.
13. Before starting the engine disengage all blades and drive clutches.
14. Keep your feet well away from the blade when starting the engine and in accordance with the instructions.
15. Do not tilt the lawn mower when starting the engine and always start on a flat surface free from long grass.

16. Do not start the engine when standing in front of the discharge chute.
17. Never put hands or feet near or under rotating parts. Keep clear of the discharge opening at all times.
18. Always ensure the engine is fully switched off before picking up/carrying the Lawnmower.
19. Stop the engine and disconnect the spark plug wire, make sure that all moving parts have come to a complete stop and, where a key is fitted remove the key, make sure engine has had time to cool.
 - Before unclogging chute and clearing blockages.
 - Before checking, cleaning or working on the lawn mower.
 - After striking a foreign object. Inspect the lawnmower for damage and make repairs before restarting.
 - If the lawn mower starts to vibrate abnormally (check immediately).
20. Stop the engine and disconnect the spark plug wire, make sure that all moving parts have come to a complete stop and, where a key is fitted remove the key, make sure engine is completely cooled.
 - Whenever you leave the lawn mower.
 - Before refuelling.
21. Reduce the throttle setting during engine shut down and, if the engine is provided with a shut-off valve, turn the fuel valve off at the conclusion of mowing.

Maintenance and Storage

1. Keep all nuts, bolts and screws tight to be sure the equipment is in safe working condition.
2. Never store the equipment with petrol in the tank inside a building where fuel vapours can reach an open flame or spark or where the temperature is high.
3. Before storage allow the engine to cool.
4. To reduce the fire hazard, keep the engine, silencer, battery compartment and petrol storage area free of grass, leaves, or excessive grease.
5. Check the grass catcher and deflector frequently for wear or deterioration.
6. Replace worn or damaged parts for safety. Genuine parts should always be used as parts of inferior quality can damage the equipment and compromise safety.
7. If the fuel tank has to be drained, this should be done outdoors. Always ensure engine is completely cooled before starting this task.
8. If the blade needs to be removed, wear strong gloves to prevent injury to hands and fingers. Check the blades balance after sharpening.
9. When transporting the machine make sure you close the fuel cut off. Be careful to ensure weight is evenly distributed. Wear strong gloves.
10. When tilting the machine never tilt towards the air filter as this may become damaged with fuel.
11. Never crank the engine when the spark plug is removed.
12. Frequently check the fuel lines and fittings for damage and cracks, replace if necessary
13. Never start the engine with the air filter cover removed.
14. Carefully clean the mower and grass bag after use to remove debris as this can damage and corrode.

Fertilisers and top dressings are particularly corrosive.

15. In time your chassis may peel because of the abrasive action of the debris making contact. This can be remedied by touching up paintwork where necessary to prevent corrosion.



Warning: Do not touch rotating blade.



Warning: Refuel in a well ventilated area with the engine stopped.

3. PARTS DESCRIPTION

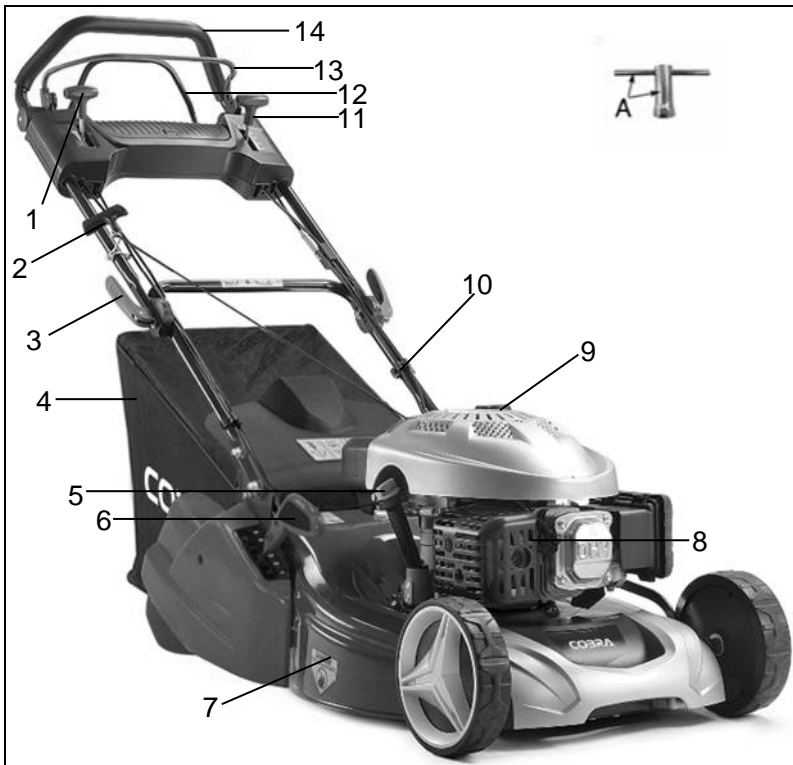

Fig.1

- | | | | |
|--------------------------|---------------------------|---------------------------|-------------------------------|
| 1. Throttle choke lever | 2. Starter handle | 3. Locking lever | 4. Grass catcher |
| 5. Oil cap | 6. Height adjusting lever | 7. Deck | 8. Spark plug |
| 9. Fuel cap | 10. Cable clamp | 11. Speed adjusting lever | 12. Self-drive control handle |
| 13. Brake control handle | 14. Upper handle | | |

Including: A: Spark plug wrench

4. TECHNICAL DATA

Model	RM514SC (DYM162611)
Engine Type	DG600
Engine Displacement	173cm ³
Nominal Power	2.9kW
Blade Width	510 mm
Rated Speed	2800/min
Fuel Tank Capacity	2.0L
Grass Catch Bag Capacity	70L
Net Weight	46.5 kg
Height Adjustment	17-75mm 6 adjustment

Measured Sound pressure	86.3 dB(A)
-------------------------	------------

level at operator's position (According to EN ISO 5395-1 Annex F & EN ISO 5395-2, EN ISO 4871)	K=3dB(A)
Measured sound power level Guaranteed Sound Power level (According to 2000/14/EC)	96.6B(A) K=1.83dB(A) 98 dB(A)
Vibration (According to EN ISO 5395-1 Annex G & EN ISO 5395-2)	5.65m/s ² K=1.5 m/s ²

5. ASSEMBLY

5.1 FOLDING HANDLE

1. Fix the lower handlebars into the unit body with a suitable spanner. (Fig.2A/Fig.2B/Fig.2C)
2. Lift the two locking levers to release the upper handlebars for folding. (Fig. 2D)
3. Push the locking lever closed to lock the handlebars in the operating position. (Fig.2E)
4. Adjust the tension by turning the lock nut with a suitable spanner. (Fig.2F)
5. Attach the cable-clamp to the position shown and then attach the cable. (Fig.2G)



Fig.2A



Fig.2B



Fig.2C



Fig.2D



Fig.2E



Fig.2F



Fig.2G

5.2 ADJUSTMENT FOR AN APPROPRIATE ANGLE

1. Pull the locking lever opening;
2. Rotate the upper handle to the required angle between -20° to 20° as the Fig.3 shown;
3. Push the locking lever to the closed position to lock the lower handle and the upper handle.

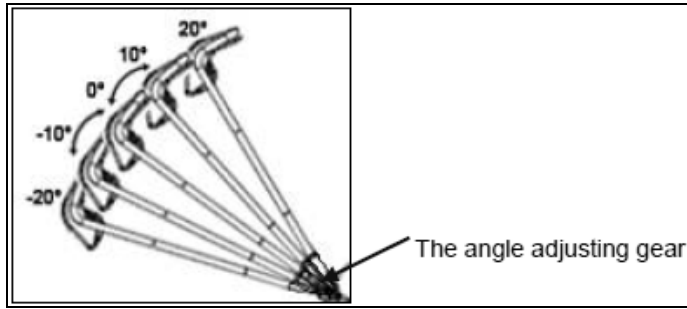

Fig.3

5.3 MOUNTING AND DISMOUNTING THE GRASS CATCHER

1. To fit: Raise the rear cover and hitch the grass catcher on rear of the mower. (Fig.4A/4B/4C)
2. To remove: grasp and lift the rear cover. Remove grass catcher.



Fig.4A



Fig.4B



Fig.4C

5.4 STARTER HANDLE

Move the starter handle from the engine to the rope guide. (Fig.5A/5B)

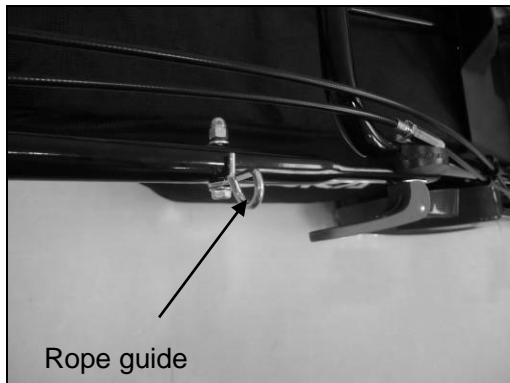

Fig.5A



Fig.5B

5.5 HEIGHT OF CUT

Apply outward pressure to disengage lever from the rack. Move the lever forward or back to adjust height. (Fig.6)



Fig. 6

5.6 Rear Roller

The wide rear roller cuts right up to the edge of borders and creates a classic stripe so you'll achieve a beautiful finish to your lawn with ease.(Fig.7A/7B)

The lawn's appearance will be improved if it is cut regularly and is cut in alternate directions.

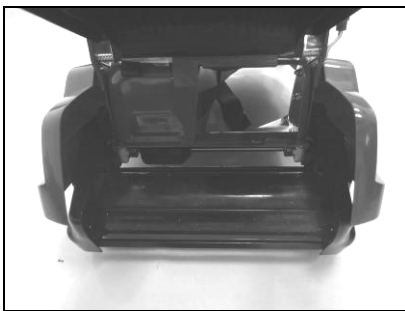

Fig.7A

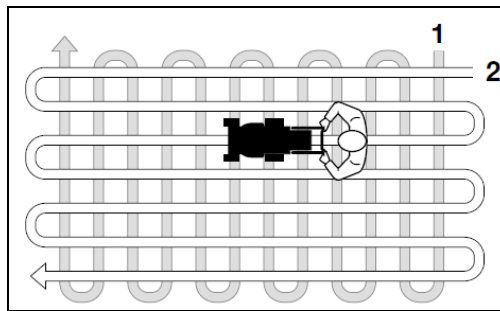

Fig.7B

5.7 Tool Box

This type of lawn mower has a tool box. Push the button to open it, and then press the cover to lock it. The tool box is ideal gardening gloves, spanner or screwdriver in the box.



Fig.8

6. OPERATING INSTRUCTIONS

6.1 BEFORE STARTING

Service the engine with petrol and oil as instructed in the separate engine manual packed in your mower. Read the instructions carefully.

⚠️ WARNING! Petrol is highly flammable.

Store fuel in containers specifically designed for this purpose.

Refuel outdoors only. Do not smoke whilst refueling or handling. Keep away from any potential ignition sources,

such flames or sparks.

Never remove the cap of the fuel tank or add petrol while the engine is running or when the engine is hot.

If petrol is spilled, do not attempt to start the engine, but move the machine away from the area of spillage and avoid creating any source of ignition until petrol vapors have dissipated.

Replace all fuel tanks and container caps securely.

Before tipping the lawn mower to maintain the blade or drain oil, remove fuel from tank and the spark plug connector.

⚠ WARNING: Never fill fuel tank indoors, with engine running or until the engine has been allowed to cool for at least 15 minutes after running.

6.2 TO START ENGINE AND ENGAGE BLADE

1. The unit is equipped with a rubber boot over the end of the spark plug, make certain the metal loop on the end of the spark plug wire (inside the rubber boot) is fastened securely over the metal tip on the spark plug.

2. Before starting engine, please turn the fuel lock to the “” position. (Fig.9A)

3. When starting a cool engine, turn throttle choke lever to “” position.

When starting warm engine and operating, turn throttle chock lever to “” position. (Fig.9B)

4. Standing behind the unit, grasp the brake control handle and hold it against the upper handle as shown in Fig. 9C.

5. Grasp the starter handle as shown Fig.9C and pull up rapidly. Return it slowly to the rope guide bolt after the engine starts.

6. Release the brake control handle to stop the engine and blade.

7. When you finish mowing each time, please turn the fuel lock to the “” position. (Fig.9D)

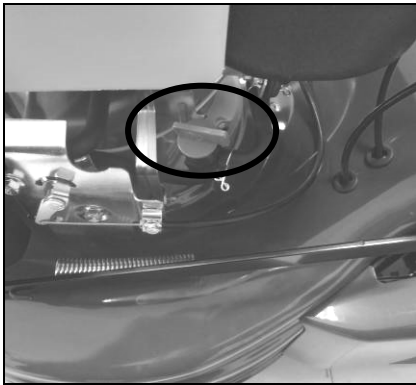

Fig.9A



Fig.9B

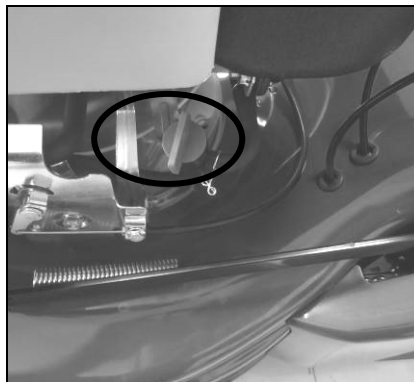
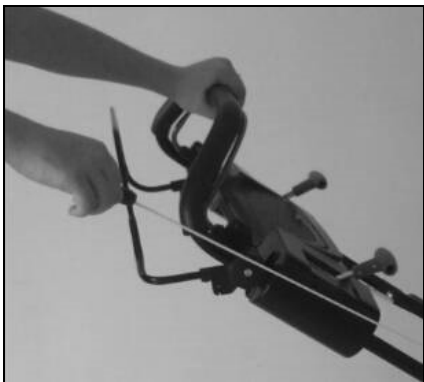

Fig.9C

Fig.9D

- ⚠ Start the engine carefully according to the instructions and with feet well away from the blade.
- ⚠ Do not tilt the lawn mower when starting the engine. Start the mower on a level surface, free of high grass or obstacles.
- ⚠ Keep hands and feet away from the rotating parts. Do not start the engine when standing in front of the discharge opening.

6.3 OPERATION PROCEDURES

During operation, tightly hold the brake handle with both hands.

⚠ **Note:** During operation, when the brake handle is released, the engine will stop and stop the lawnmower from operating.

Warning! In order to avoid any unintentional start-ups of the lawn mower, it comes equipped with an engine brake which must be pulled back before the engine can be started. When the engine control lever is released it must return to its initial position, at which point the engine automatically switches off.

Note: Engine brake (brake handle): Use the lever to stop the engine. When you release the lever the engine and the blade stops automatically. To mow, hold the lever in the working position. Before you start to mow, check the start/stop lever several times to be sure that it is working properly. Ensure that the tension cable can be smoothly operated (i.e. is not catching or kinking in any way)

6.4 TO STOP ENGINE

⚠ **CAUTION:** The blade continues to rotate for a few seconds after the engine is shut off.

1. Release the brake control handle to stop the engine and blade.
2. Disconnect and ground the spark plug wire as instructed in the separate engine manual to prevent accidental starting while equipment is unattended.

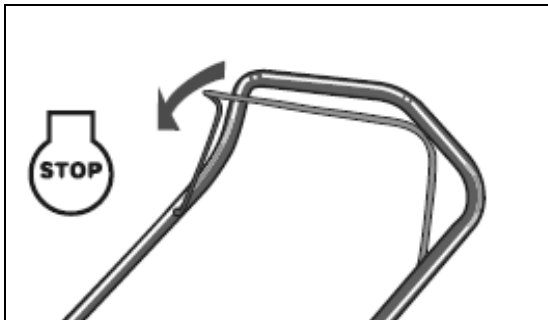

Fig.10

⚠ **CAUTION:** The blade continues to rotate for a few seconds after the engine is shut off.

6.5 LEVER FOR POWERED DRIVE

The mower is equipped with a speed adjusting system which can adjust 4 speeds from 3.0km/h to 4.5 km/h. Position 1: the slowest position; Position 4: the fastest position. (Fig.11B)

The step as below:

1. Release the self-drive control handle until the lawn mower doesn't go forward.
2. Adjust the appropriate speed which you want.
3. Grasp the self-drive control handle to go on mowing. (Fig.11A)

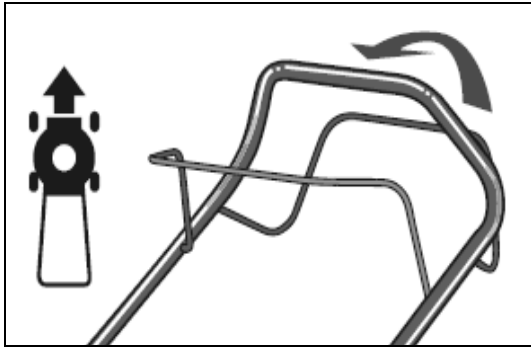

Fig.11A



Fig.11B

⚠ CAUTION: your mower is designed to cut normal residential grass of a height no more than 250mm.

Do not attempt to mow through unusually tall dry or wet grass (e.g., pasture) or piles of dry leaves. Debris may build up on the mower deck or contact the engine exhaust presenting a potential fire hazard.

6.6 FOR THE BEST RESULTS WHEN MOWING

Clear lawn of debris: Be sure that the lawn is clear of stones, sticks, wire or other objects, which could be accidentally thrown out by the mower in any direction and cause serious injury to the operator and others as well as damage to property and surrounding objects.

Avoid cutting wet grass: For effective mowing do not cut wet grass, because it tends to stick to the underside of the deck preventing proper mowing of the grass clippings.

General Recommendations: Cut no more than 1/3 the length of the grass. The recommended cut for mowing is 1/3 the length of the grass. Ground speed will need to be adjusted so the clippings can be dispersed evenly into the lawn. For especially heavy cutting in thick grass it may be necessary to use one of the slowest speeds in order to get a clean well mowed cut. When mowing long grass you may have to cut the lawn in two passes, lowering the blade another 1/3 of the length for the second cut and perhaps cutting in a different pattern than was used the first time. Overlapping the cut a little on each pass will also help to clean up any stray clippings left on the lawn. The mower should always be operated at full throttle to get the best cut and allow it to do the most effective job of mowing.

Clean underside of deck: Always disconnect the spark plug connector before undertaking any maintenance. Be certain to clean the underside of the cutting deck after each use to avoid a build-up of grass, which would prevent proper mulching. Mowing leaves. The mowing of leaves can also be beneficial to your lawn. When mowing leaves make sure they are dry and are not laying too thick on the lawn. Do not wait for all the leaves to be off the trees before you mow.

⚠ WARNING: If you strike a foreign object, stop the engine. Remove wire from spark plug, thoroughly inspect the mower for any damage and repair the damage before restarting and operating the mower. Extensive vibration of the mower during operation is an indication of damage. The unit should be promptly inspected and repaired.

6.7 GRASS CATCHER

If the grass catcher is full of grass, you will need to empty and clean the grass catcher, make sure it is clean and ensure its meshwork is ventilated. (Fig.12)

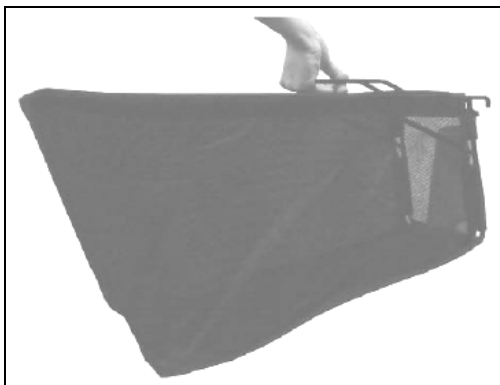

Fig.12

6.8 DECK

The underside of the mower deck should be cleaned after each use to prevent a buildup of grass clippings, leaves, dirt or other matter. If this debris is allowed to accumulate, it will invite rust and corrosion, and may prevent proper mulching. The deck may be cleaned by tilting the mower and scraping clean with a suitable tool (make certain the spark plug wire is disconnected).

6.9 HEIGHT ADJUSTMENT INSTRUCTIONS

⚠ CAUTION: Do not at any time make any adjustment to lawnmower without first stopping the engine and disconnecting the spark plug wire.

⚠ CAUTION: Before changing mowing height, stop mower and disconnect spark plug cable.

Your mower is equipped with a central height adjustment lever offering 6 height positions.

The height (the blade to the ground) can be adjusted from 17mm (position 1) to 75 mm (position 6).

1. Stop the mower and disconnect spark plug cable before changing the mower cutting height.
2. The central height adjustment lever offers you 6 different height positions.
3. To change the height of cut, squeeze the adjuster lever away from the engine, moving up or down to selected the required height. (Fig.13)



Fig.13

7. MAINTENANCE INSTRUCTIONS

SPARK PLUG

Use only original replacement spark plug. For best results, replace the spark plug every 100 hours of use.

BRAKE PADS

Check and/or replace the engine brake pads at the service agent regularly, only original parts can be used as replacements.

8. LUBRICATION INSTRUCTIONS

⚠ CAUTION: DISCONNECT THE SPARK PLUG BEFORE SERVICING.

1. WHEELS-Lubricate the ball bearings in each wheel at least once a season with a light oil.
2. ENGINE-Follow engine manual for lubrication instructions.

9. CLEANING

⚠ CAUTION: Do not hose engine. Water can damage the engine or contaminate the fuel system.

1. Wipe deck with dry cloth.
2. Hose the under deck by tilting the mower so that the spark plug is up.

9.1 ENGINE AIR CLEANER

⚠ CAUTION: Do not allow dirt or dust to clog the air filter foam element. The engine air cleaner element must be serviced (cleaned) after 25 hours normal mowing. The foam element must be serviced regularly if the mower is used in dry dusty conditions.

To CLEAN AIR FILTER

1. Press down the two tabs on top of the filter cover.
2. Remove cover. (Fig.14A)
3. Where a foam element is fitted, wash the filter element in soap water. (Fig.14B)**DO NOT USE GASOLINE!**
4. Air dry filter element.
5. Place a few drops of SAE30 oil on the foam filter and squeeze tightly to remove any excess oil.
6. Reinstall filter. Simply replace paper filters.

NOTE: Replace filter if frayed, torn, damaged or unable to be cleaned.

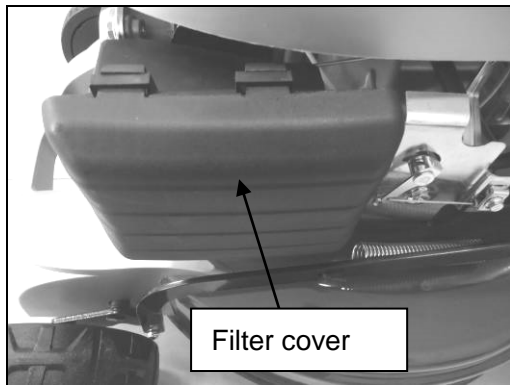

Fig.14A

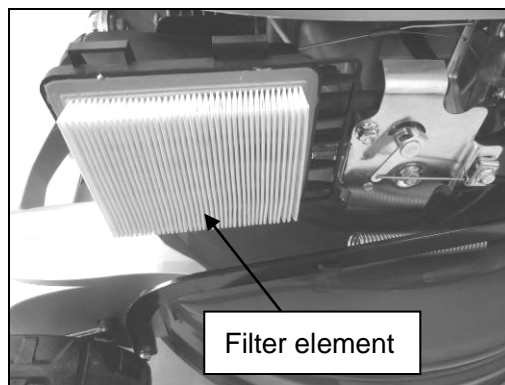

Fig.14B

9.2 CUTTING BLADE

⚠ CAUTION: Be sure to disconnect and ground the spark plug wire before working on the cutting blade to prevent accidental engine starting. Protect hands by using heavy gloves or a rag to grasp the cutting blades. Tip the mower as specified in the separate engine manual. Remove the hex bolt and washer which holds the blade and blade adapter to the engine crankshaft. Remove the blade and adapter from the crankshaft.

⚠ WARNING: Periodically inspect the blade adapter for cracks, especially if you strike a foreign object. Replace when necessary. For best results your blade should be sharp. Slightly worn blades may be re-sharpened with care. After removing the blade, it may be ground or filed, so that the cutting edge is as close

to the original bevel as possible. It is extremely important that each cutting edge receives an equal amount of grinding to prevent an unbalanced blade. Improper blade balance will result in excessive vibration causing damage to the engine and mower. Be sure to carefully balance blade after sharpening. The blade can be tested for balance by balancing it on a round shaft screwdriver. Remove metal from the heavy side, until it balances evenly.

Before reassembling the blade and the blade adapter to the unit, lubricate the engine crankshaft and the inner surface of the blade adapter with light oil. Install the blade adapter on the crankshaft. Refer Fig.15. Place the blade with the part number facing away from the adapter. Align the washer over the blade and insert the hex bolt. Tighten the hex bolt to the torque listed below:

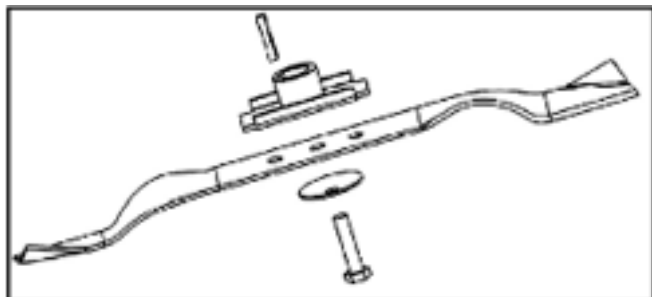

Fig.15

9.3 BLADE MOUNTING TORQUE

Center Bolt 35Nm-45Nm, to insure safe operation of your unit. ALL nuts and bolts must be checked periodically for correct tightness. After prolonged use, especially in sandy soil conditions, the blade will become worn and lose some of the original shape. Cutting efficiently will be reduced and the blade should be replaced. Replace with an approved factory replacement blade only. Possible damage resulting from blade unbalance condition is not the responsibility of the manufacturer. When you change the blade, must use the original type marked on the blade (263001330).For order the blade, please contact your local dealer or call Cobra.

9.4 ENGINE

Refer to the separate engine manual for engine maintenance instructions.

Maintain engine oil as instructed in the separate engine manual packed with your unit. Read and follow instructions carefully. Service air cleaner as per separate engine manual under normal conditions.

Clean every few hours under extremely dusty conditions. Poor engine performance and flooding usually indicates that the air cleaner should be serviced.

To service the air cleaner, refer to the separate engine manual packed with your unit.

The spark plug should be cleaned and the gap reset once a season. Spark plug replacement is recommended at the start of each mowing season; check the engine manual for the correct plug type and gap specifications. Clean the engine regularly with a cloth or brush. Keep the cooling system (blower housing area) clean to permit proper air circulation, which is essential for engine performance and reliability. Be certain to remove all grass, dirt and combustible debris from muffler area.

10. STORAGE INSTRUCTIONS (OFF SEASON)

The following steps should be taken to prepare the lawn mower for storage.

1. Empty the tank after the last mowing of the season.
 - a) Empty the petrol tank with a suction pump.

⚠ CAUTION! Do not drain the petrol in closed rooms, in close proximity of an open fire, etc. Do not smoke! Petrol fumes can cause an explosion or fire.

- b) Start the engine and let it run until it has used up all remaining petrol and stalls.
 - c) Remove the spark plug. Use an oilcan to fill approx. 20 ml oil into the combustion chamber. Operate the starter to evenly distribute the oil in the combustion chamber. Replace the spark plug.
2. Clean and grease the lawnmower carefully as described above under "Lubrication".
 3. Slightly grease the cutter to avoid corrosion.
 4. Store the lawnmower in a dry, clean and frost-protected place, out of reach of unauthorised persons.



CAUTION! The engine must have completely cooled down before storing the lawnmower.



NOTE:

- When storing any type of power equipment in an unventilated or material storage shed. -Care should be taken to rust-proof the equipment. Using a light oil or silicone, coat the equipment, especially cables and all moving parts.
- Be careful not to bend or kink cables.
- If the starter rope becomes disconnected from the rope guide on the handle, disconnect and ground the spark plug wire, Depress the blade control handle and pull the starter rope out from the engine slowly. Slip the starter rope into the rope guide bolt on the handle.

Transport

Turn the engine off and allow the engine to cool down. Then disconnect the spark plug wire and empty the fuel tank according to the instructions in the engine manual. Make sure not to bend or damage the cutter when pushing the lawnmower over obstacles.

11. TROUBLES SHOOTING

PROBLEM	PROBABLE CAUSE	CORRECTIVE ACTION
Engine does not start.	Fuel tank is empty.	Fill tank with fuel: refer to ENGINE OWNERS MANUAL.
	Air cleaner element is dirty.	Clean air cleaner element: refer to ENGINE OWNERS MANUAL
	Spark plug loose.	Tighten spark plug : refer to ENGINE OWNERS MANUAL
	Spark plug wire loose or disconnected from plug.	Install spark plug wire on spark plug.
	Spark plug gap is incorrect.	Set the gap between electrodes: refer to ENGINE OWNERS MANUAL
	Spark plug is defective	Install new, correctly gapped plug: refer to ENGINE OWNERS MANUAL
	Carburetor is flooded with fuel	Remove the air cleaner element and pull starter rope continuously until carburetor clears itself and install air cleaner element.
	Faulty ignition module	Contact the service agent.
Engine difficult to start or loses power.	Dirt, water, or stale in the fuel tank.	Drain fuel and clean the tank. Fill the tank with clean, fresh fuel
	Vent hole in fuel tank cap is plugged.	Clean or replace fuel tank cap.
	Air cleaner element is dirty.	Clean air cleaner element.
Engine operates erratically.	Spark plug is defective.	Install new, correctly gapped plug: refer to ENGINE OWNERS MANUAL
	Spark plug gap is incorrect.	Set gap between electrodes: refer to ENGINE OWNERS MANUAL
	Air cleaner element is dirty.	Clean the air cleaner element: refer to ENGINE OWNERS MANUAL
Engine idles poorly.	Air cleaner element is dirty.	Clean air cleaner element: refer to ENGINE OWNERS MANUAL
	Air slots in engine shroud are blocked.	Remove debris from the shroud.
	Cooling fins and air passages under engine blower housing are blocked.	Remove debris from the cooling fins and air passages.
Engine skips at high speed.	Gap between electrodes of spark plug is too close.	Set gap between electrodes: refer to ENGINE OWNERS MANUAL
Engine overheats	Cooling air flow is restricted.	Remover any debris from slots in shroud, blower housing, air passages
	Incorrect spark plug.	Install spark plug and clear cooling fins on the engine.
Mower vibrates abnormally	Cutting assembly is loose.	Tighten blade
	Cutting assembly is unbalanced	Balance blade.

12. WARRANTY

This product is warranted in accordance with legal regulations for a 24 month period effective from the date of purchase by the first user.

This product will not be covered if used in a commercial application.

This warranty covers all material or production failures, it does not include: defects from normal wear and tear, parts such as, bearings, brushes, cables, air cleaning elements, brake pad, clutch disc, tyre, wheel, recoil starter rope, belts, cutter blades, plugs, lubricant oils and grease or accessories. Damage or defects resulting from abuse, accidents or alterations, natural fading of painted or plated surfaces, sheet peeling and other natural deterioration.

Any damage that occurs from the use of non-genuine Cobra parts will not be covered.

We reserve the right to reject any claim where the purchase cannot be verified or when it is clear that the product was not maintained properly. (Clean ventilation slots, carbon brushes and serviced regularly)

Expenses incidental to the warranty claim that are not covered;

-Compensation for loss of time, commercial loss or rental costs of substitute product.

-Costs incurred for transportation to and from the dealership.

Any damage that occurs from the following will not be covered; exposure of the product to smoke and soot, chemical agents, bird droppings or other animal waste, seawater, sea breeze, salt or other environmental phenomena.

Any damage resulting from operating methods other than those indicated in the owner's manual will not be covered.

Your purchase receipt must be kept as proof for date of purchase. Your un-dismantled mower must be returned to your dealer in an acceptably clean state, accompanied by your proof of purchase.

13. ENVIRONMENT

Should your machine need replacement after extended use, do not put it in the domestic waste but dispose of it in an environmentally safe way.

14. EC-DECLARATION OF CONFORMITY

EC Declaration of Conformity	
We herewith declare,	Cobra Garden Machinery Henton & Chattell Ltd, London Road, Nottingham NG2 3HW United Kingdom
That the following machine complies with the appropriate basic safety and health requirements of the EC Directive based on its design and type, as brought into circulation by us.	
In case of alteration of the machine, not agreed upon by us, this declaration will lose its validity	
Machine Description:	Petrol Lawn mower
Machine Type:	RM514SPC (DYM162611)
Displacement	173cm ³
Max. Cutting length:	510mm
Measured sound power level:	96.6dB(A)
Guaranteed sound power level:	98dB(A) Notified Body for EC Directive 2000/14/EC:0036 TÜV SÜD Industrie Service GmbH Westendstrasse 199 • 80686 München • Deutschland
Applicable EC Directives:	2006/42/EC 2014/30/EU 2000/14/EC 97/68/EC
Applicable Harmonized Standards:	EN ISO 5395-1 EN ISO 5395-2 EN ISO 14982
Authorized Signature/Date/ Place:	 Peter J. Chaloner 23/1/2018
Title of Signatory:	Managing Director
Name and address of the person authorised to compile the technical file	Peter J. Chaloner Cobra Garden Machinery Henton & Chattell Ltd, London Road, Nottingham NG2 3HW UK